





COMPONENTES

| | | |
|------------------------|---|------|
| TRIÁNGULO L1700 |  | 2 UD |
| GUÍA PRO 165 |  | 2 UD |
| GRAPA GUÍA PRO STANDAR | | 4 UD |
| END CLAMP |  | 4 UD |



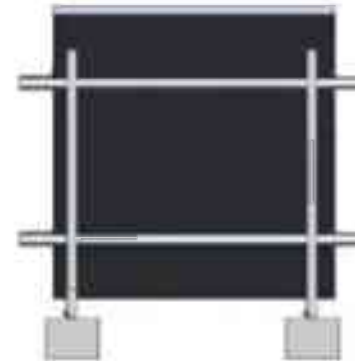
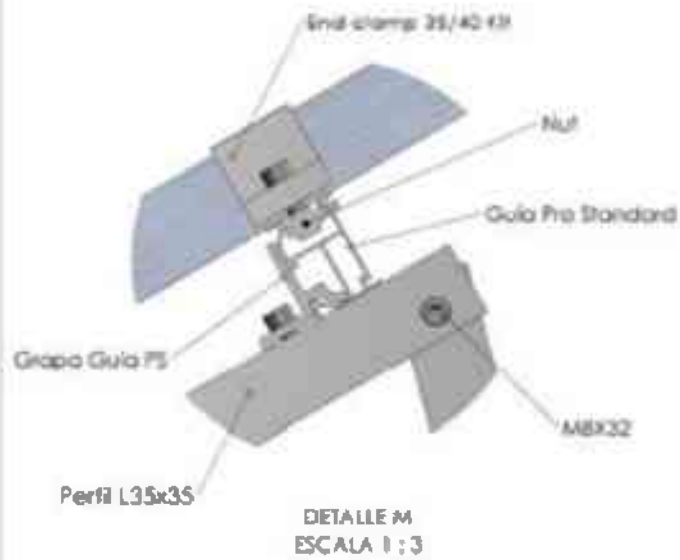
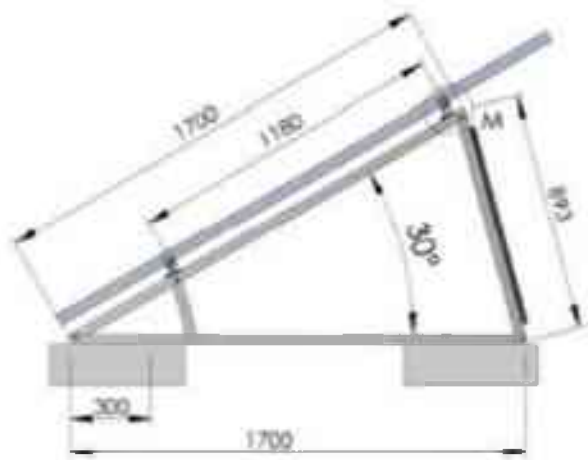

| | |
|--------------------------|--------|
| SEPARACIÓN DE TRIÁNGULOS | 100 cm |
|--------------------------|--------|

| | | | |
|---|------------------|---------|-----------|
| PLANO | DISTRIBUCIÓN 1X1 | COUNTRY | ESPAÑA |
|  Renovables del Sur Estamos cambiando el mundo | | ESCALE | PAGE SIZE |
| | | | A4 |

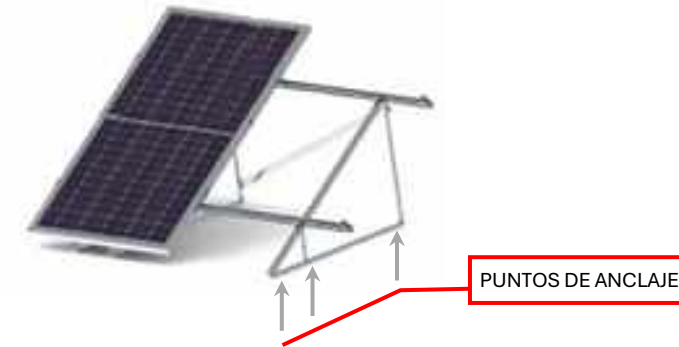
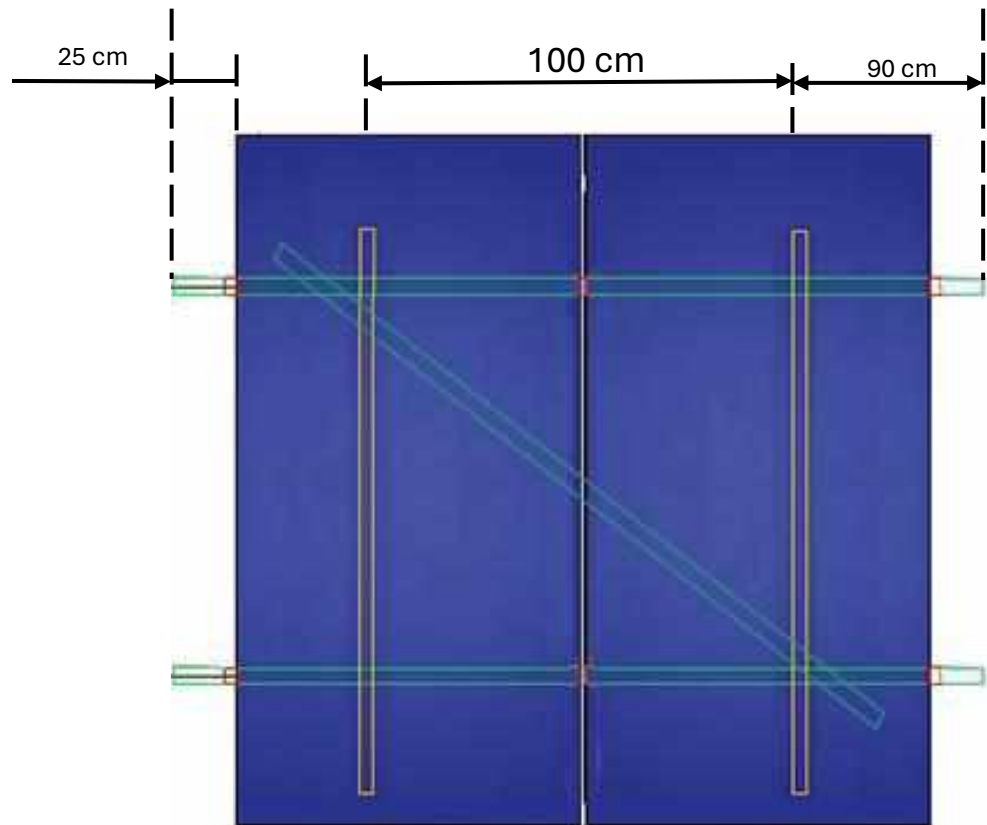



| ESTRUCTURA TRIANGULAR TI-V | | | |
|----------------------------|------------------------------|---|---------------|
| REV | FECHA | DESCRIPCIÓN | DISEÑADO |
| 1 | 19/01/2022 | Vertical | DC |
| 2 | | | |
| CUENTE | |  | |
| UBICACIÓN | | | |
| COORDENADAS | | | |
| ESCALA 1:25 | TRIÁNGULO DE SUJECCIÓN A 30° | | N° PLANO 1 |

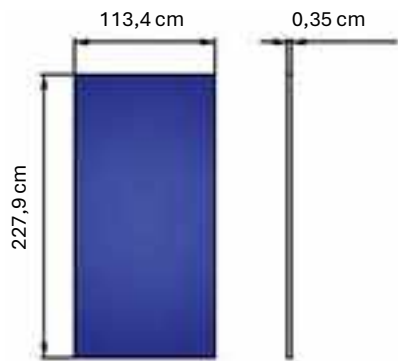

| COMPONENTES | | |
|------------------------|---|------|
| TRIÁNGULO L1700 |  | 2 UD |
| GUÍA PRO 165 |  | 2 UD |
| GUÍA PRO 115 |  | 2 UD |
| GRAPA GUÍA PRO STANDAR | | 4 UD |
| TUBO 45*20 L1445 | | 1 UD |
| KIT TORNILLERIA | | 2 UD |
| END CLAMP |  | 4 UD |
| INTER CLAMP |  | 2 UD |
| EMPALME GUÍA PRO | | 2 UD |

SEPARACIÓN DE TRIÁNGULOS **100 cm**





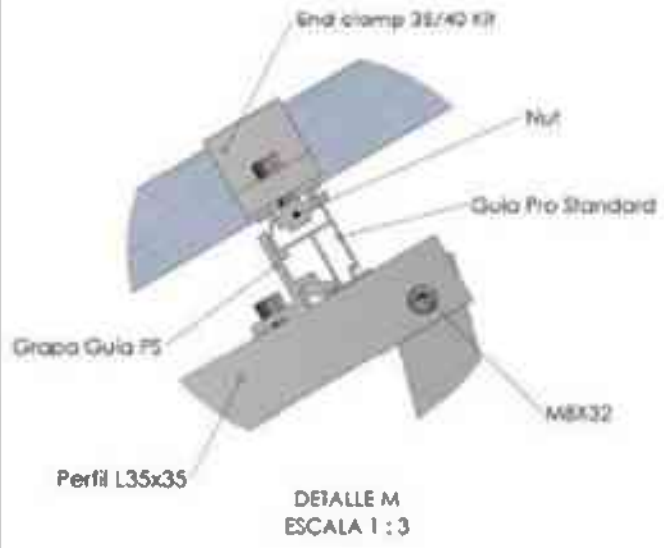
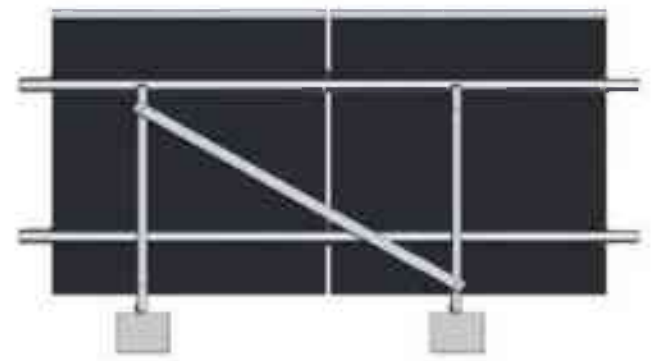
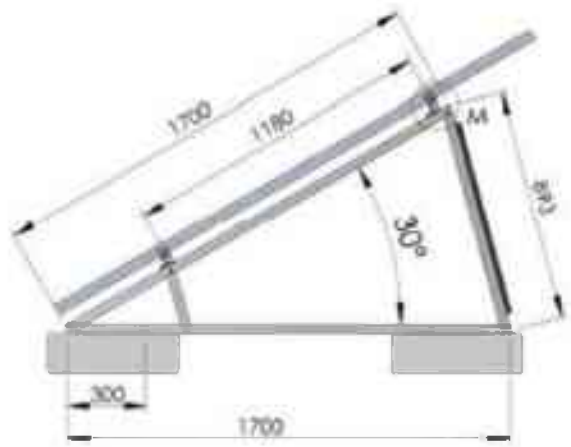

| | | | |
|---|-------------------------|---------|------------------------|
| PLANO | DISTRIBUCIÓN 1X2 | COUNTRY | ESPAÑA |
|  Renovables del Sur Estamos cambiando el mundo | | ESCALE | PAGE SIZE A4 |

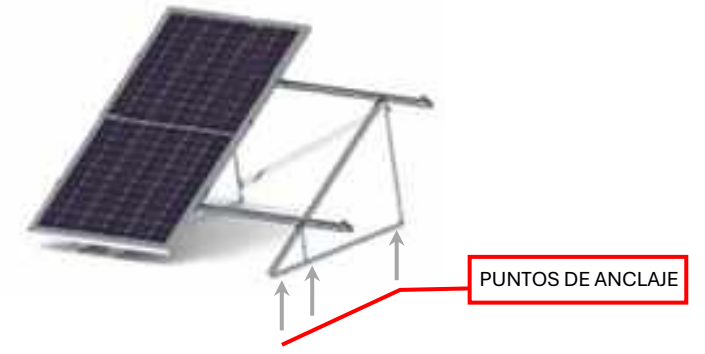
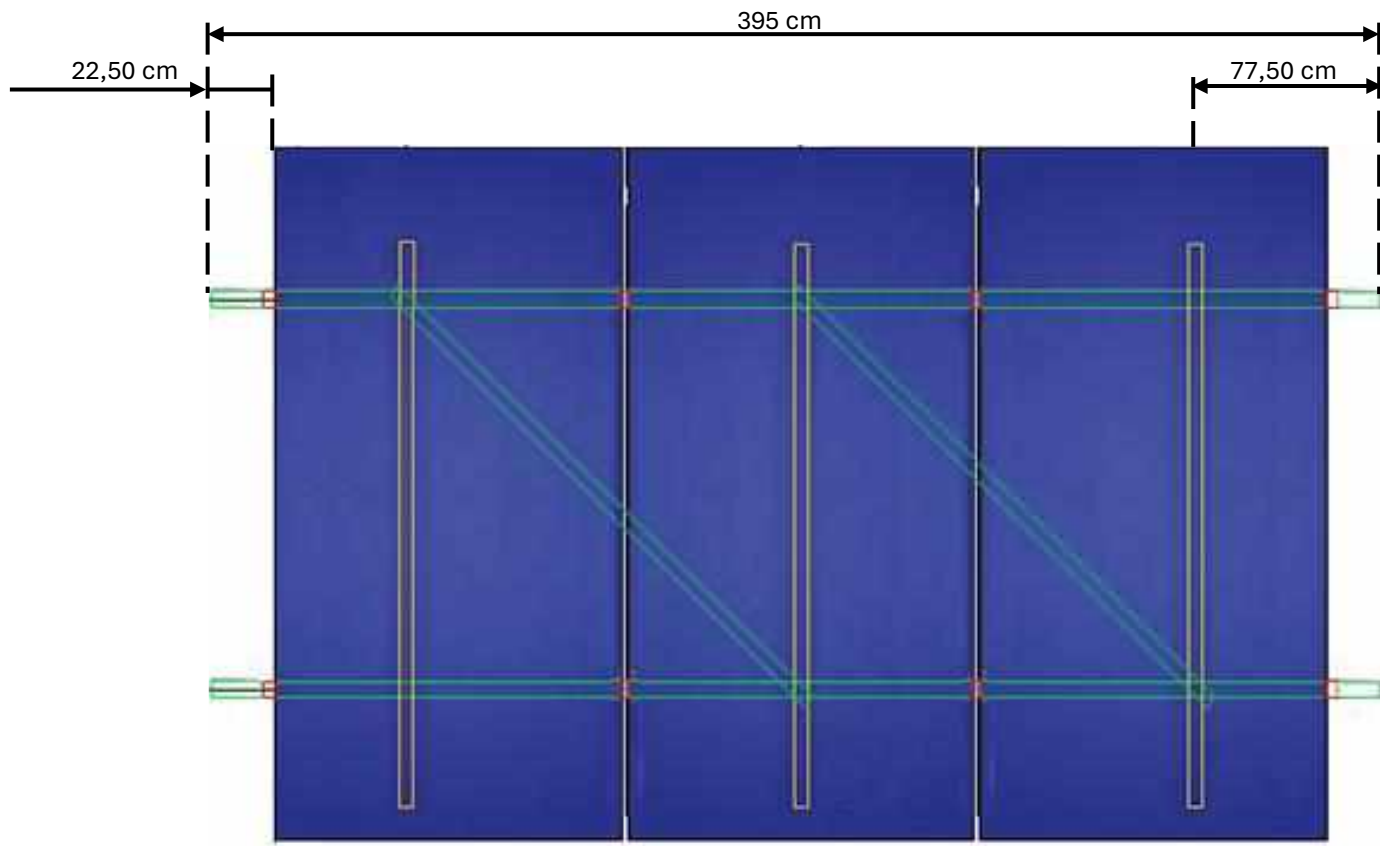



| ESTRUCTURA TRIANGULAR TI-V | | | |
|----------------------------|------------------------------|---|---------------|
| REV | FECHA | DESCRIPCIÓN | DISEÑO |
| 1 | 19/01/2022 | Vertical | DC |
| 2 | | | |
| CUENTE | |  | |
| UBICACIÓN | | | |
| COORDENADAS | | | |
| ESCALA 1 25 | TRIÁNGULO DE SUJECCIÓN A 30° | | N° PLANO 1 |

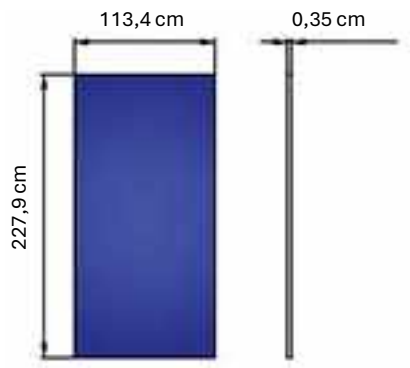

| COMPONENTES | | |
|------------------------|---|------|
| TRIÁNGULO L1700 |  | 3 UD |
| GUÍA PRO 165 |  | 2 UD |
| GUÍA PRO 115 |  | 4 UD |
| GRAPA GUÍA PRO STANDAR | | 6 UD |
| TUBO 45*20 L1445 |  | 2 UD |
| KIT TORNILLERIA |  | 4 UD |
| END CLAMP | | 4 UD |
| INTER CLAMP | | 4 UD |
| EMPALME GUÍA PRO | | 4 UD |

SEPARACIÓN DE TRIÁNGULOS **120 cm**





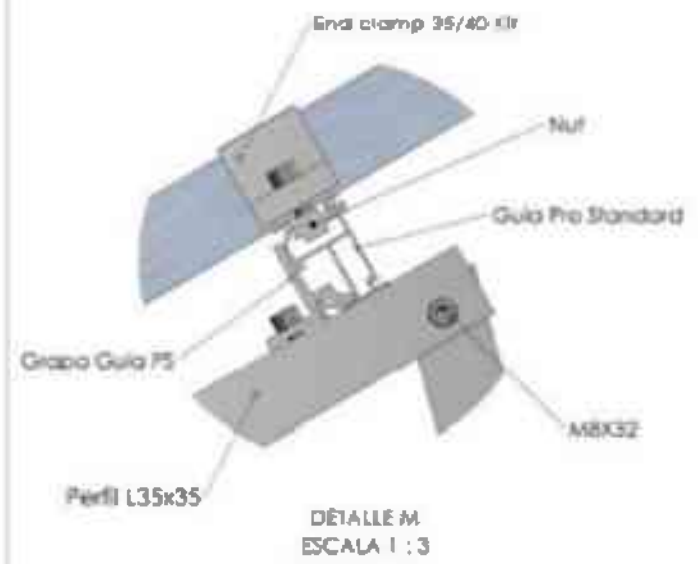
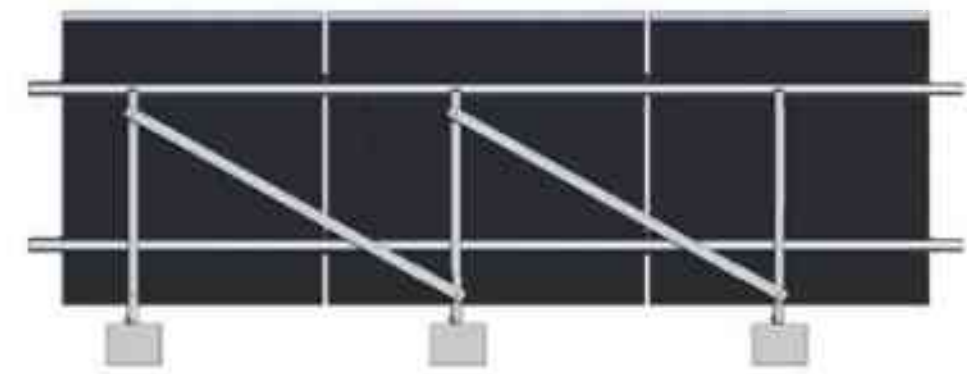
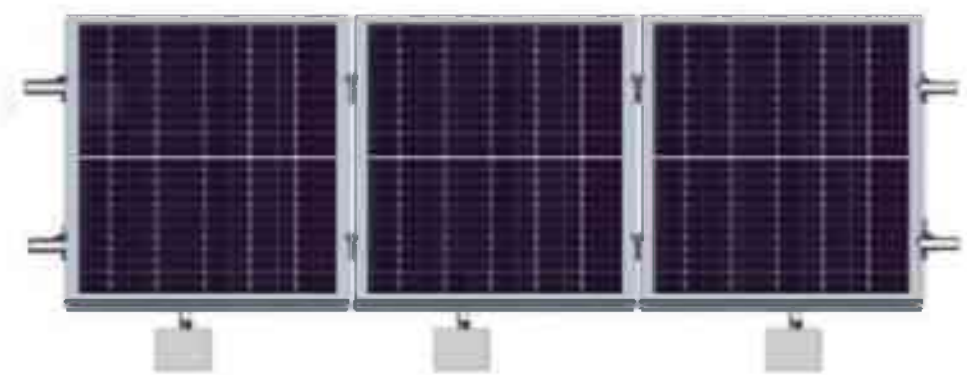
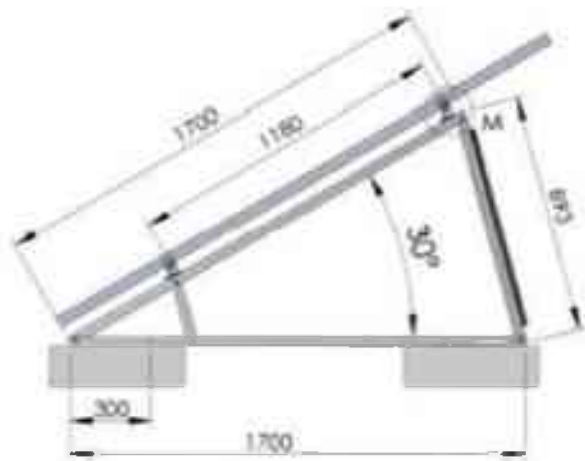

| | | | |
|---|-------------------------|---------|------------------------|
| PLANO | DISTRIBUCIÓN 1X3 | COUNTRY | ESPAÑA |
|  Renovables del Sur Estamos cambiando el mundo | | ESCALE | PAGE SIZE A4 |

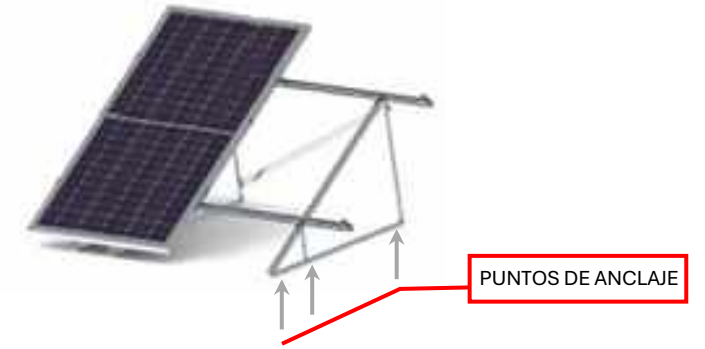
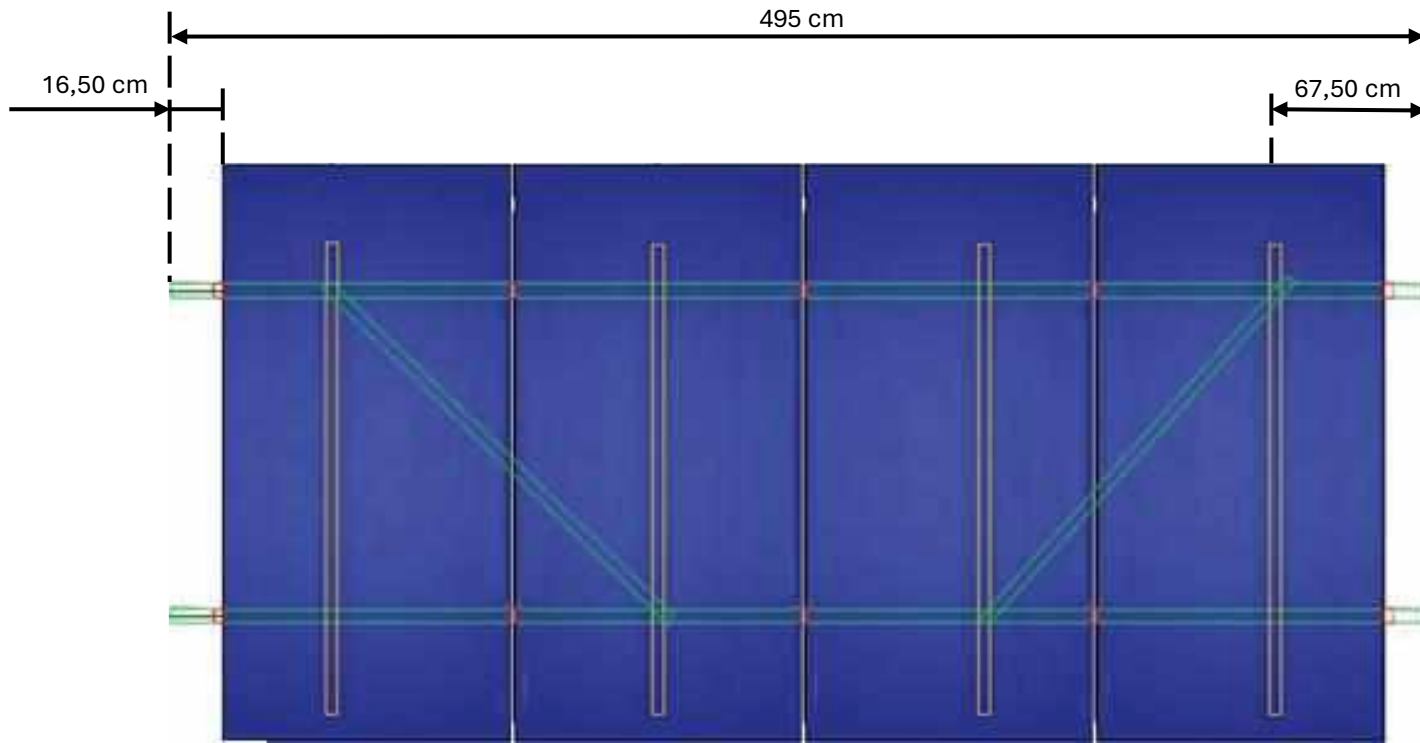

| ESTRUCTURA TRIANGULAR TI-V | | | |
|----------------------------|-----------------------------|---|----------|
| REV | FECHA | DESCRIPCIÓN | DISEÑADO |
| 1 | 19/01/2022 | Vertical | DC |
| 2 | | | |
| CLIENTE | |  | |
| UBICACIÓN | | | |
| COORDENADAS | | | |
| ESCALA | TRIÁNGULO DE SUJECIÓN A 30° | | Nº PLANO |
| 1/25 | | | 1 |



COMPONENTES

| | | |
|------------------------|---|------|
| TRIÁNGULO L1700 |  | 4 UD |
| GUÍA PRO 165 |  | 6 UD |
| GRAPA GUÍA PRO STANDAR | | 8 UD |
| TUBO 45*20 L1445 | | 2 UD |
| KIT TORNILLERIA | | 4 UD |
| END CLAMP |  | 4 UD |
| INTER CLAMP |  | 6 UD |
| EMPALME GUÍA PRO | | 4 UD |

SEPARACIÓN DE TRIÁNGULOS **120 cm**

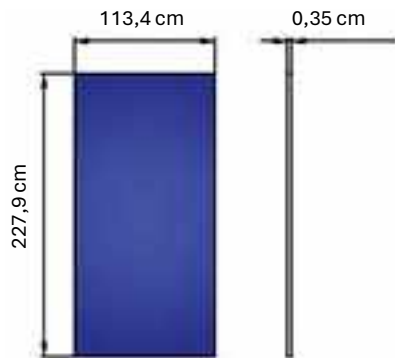



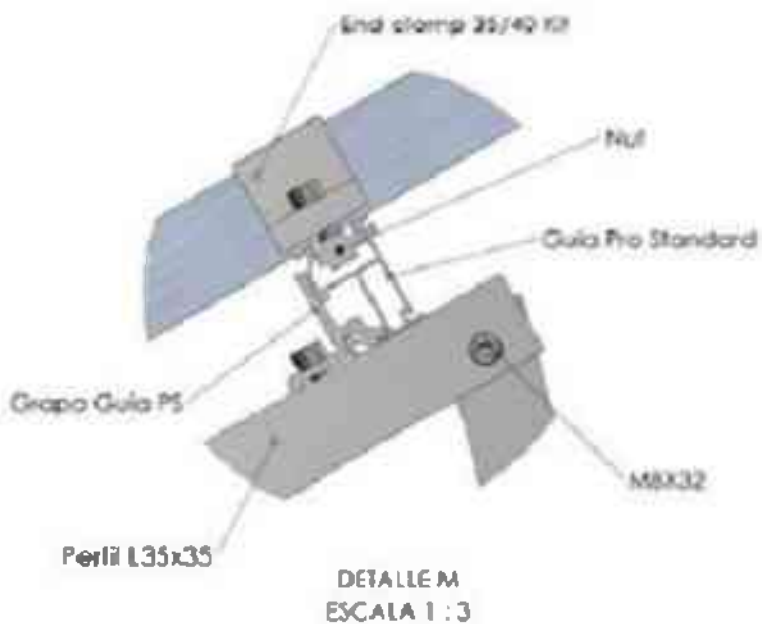
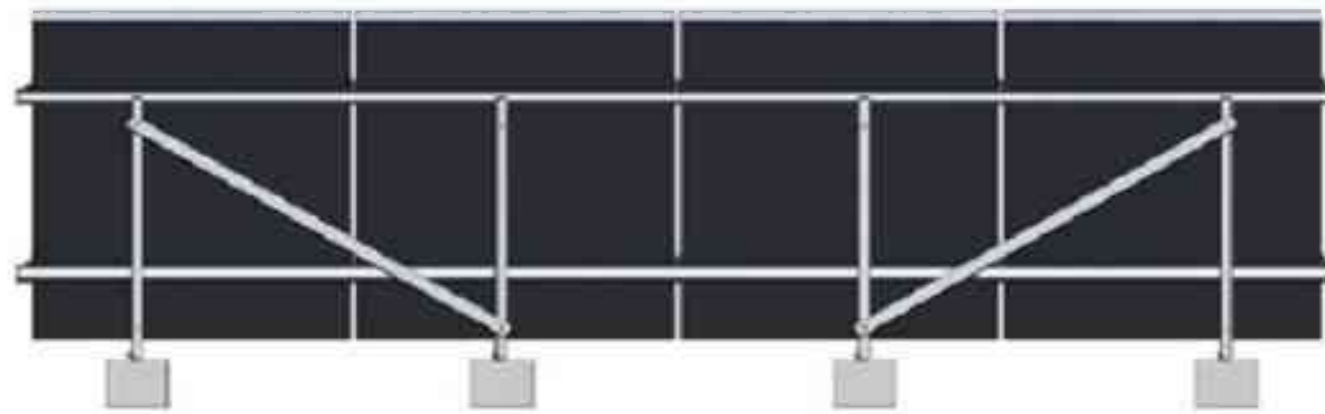
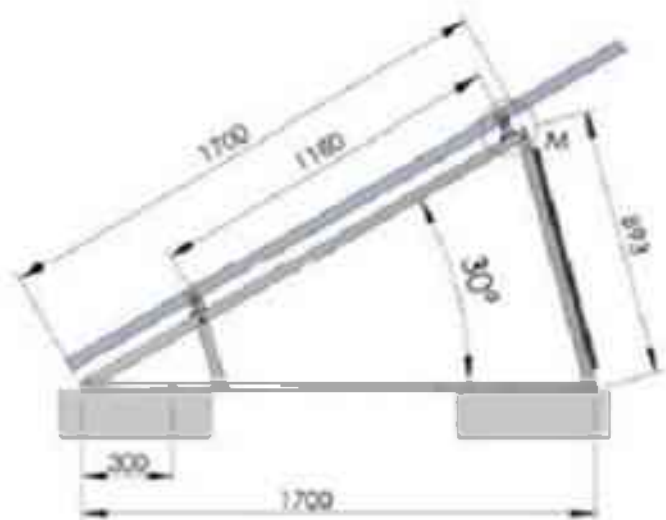

| | | | |
|---|-------------------------|---------|------------------------|
| PLANO | DISTRIBUCIÓN 1X4 | COUNTRY | ESPAÑA |
|  Renovables del Sur Estamos cambiando el mundo | | ESCALE | PAGE SIZE A4 |

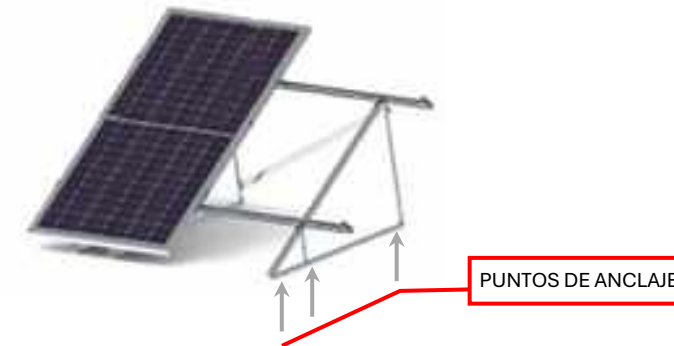
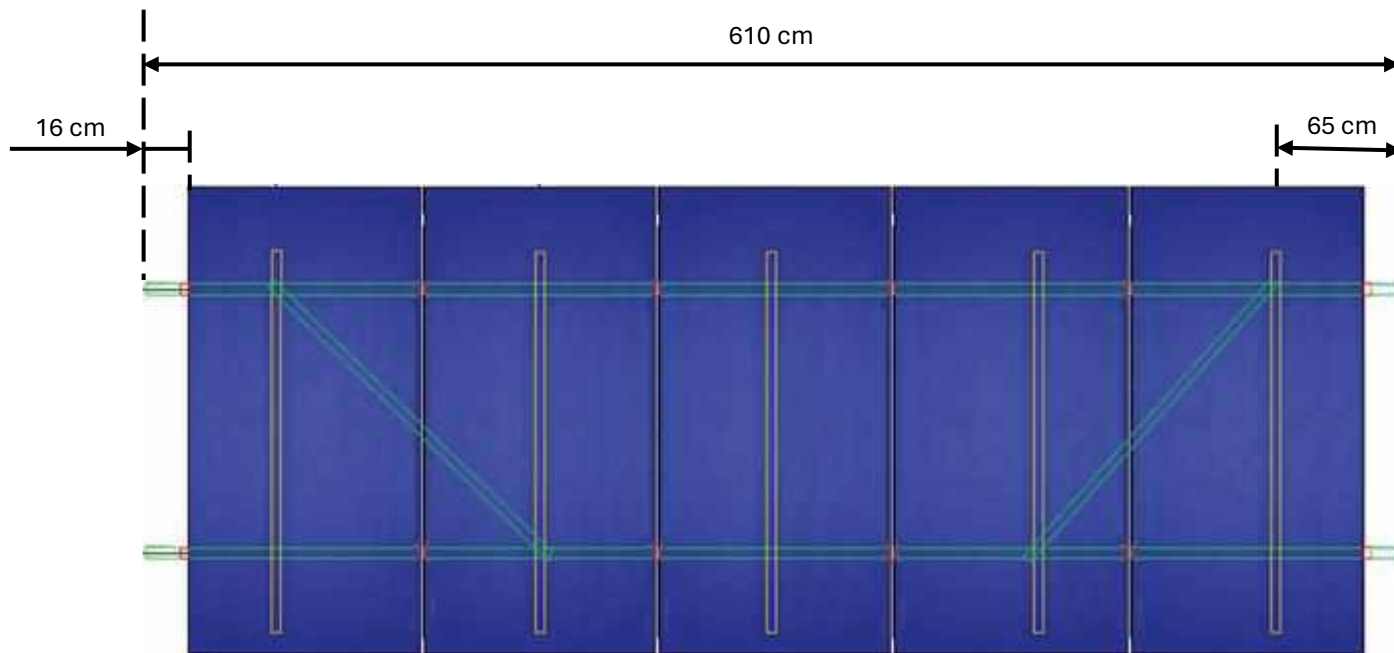

| ESTRUCTURA TRIANGULAR T-V | | | |
|---------------------------|------------------------------|---|----------|
| REV | FECHA | DESCRIPCIÓN | DISEÑADO |
| 1 | 19/01/2022 | Vertical | DC |
| 2 | | | |
| CLIENTE | |  | |
| UBICACIÓN | | | |
| COORDENADAS | | | |
| ESCALA | TRIÁNGULO DE SUJECCIÓN A 30° | | N° PLANO |
| 1:25 | | | 1 |



COMPONENTES

| | | |
|------------------------|---|-------|
| TRIÁNGULO L1700 |  | 5 UD |
| GUÍA PRO 165 |  | 6 UD |
| GUÍA PRO 115 |  | 2 UD |
| GRAPA GUÍA PRO STANDAR | | 10 UD |
| TUBO 45*20 L1445 |  | 2 UD |
| KIT TORNILLERIA |  | 4 UD |
| END CLAMP | | 4 UD |
| INTER CLAMP | | 8 UD |
| EMPALME GUÍA PRO | | 6 UD |

| | |
|--------------------------|---------------|
| SEPARACIÓN DE TRIÁNGULOS | 120 cm |
|--------------------------|---------------|

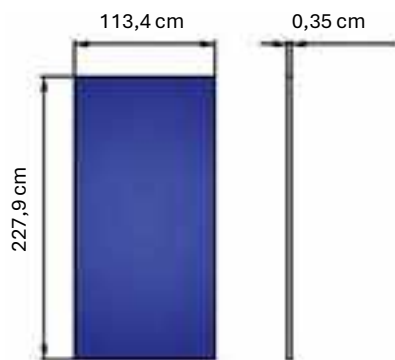

| | | | |
|---|-------------------------|---------|------------------------|
| PLANO | DISTRIBUCIÓN 1X5 | COUNTRY | ESPAÑA |
|  Renovables del Sur Estamos cambiando el mundo | | ESCALE | PAGE SIZE A4 |

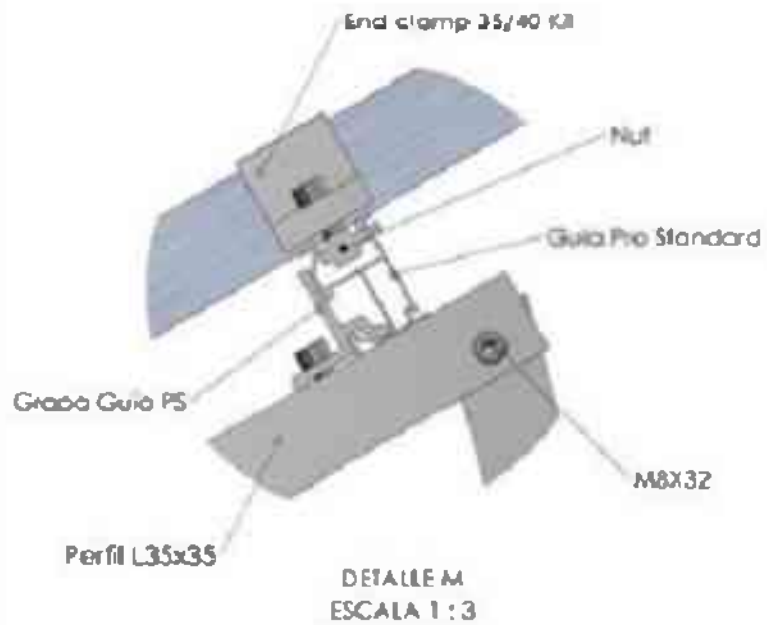
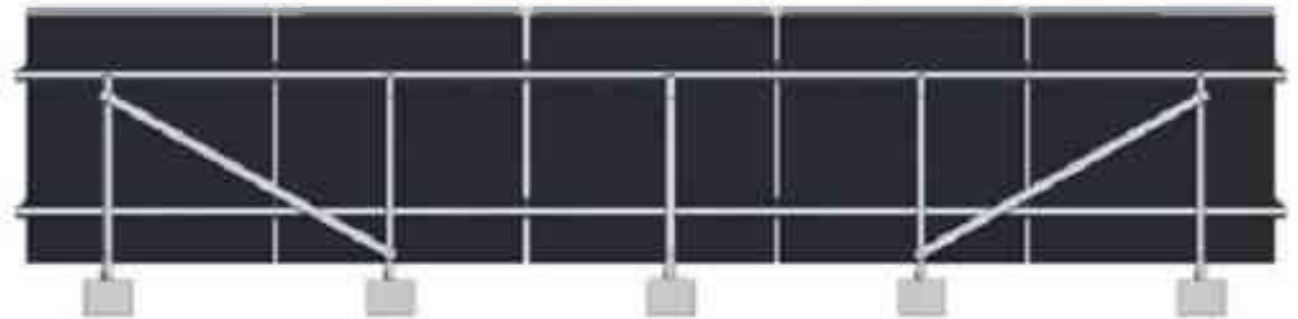
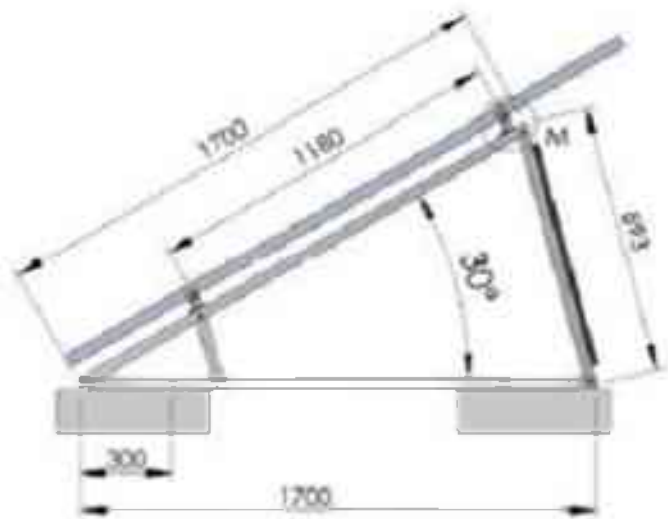

| ESTRUCTURA TRIANGULAR TI-V | | | |
|----------------------------|------------------------------|---|----------|
| REV | FECHA | DESCRIPCIÓN | DISEÑADO |
| 1 | 15/01/2022 | Vertical | DC |
| 2 | | | |
| CLIENTE | |  | |
| UBICADOR | | | |
| COORDINADOR | | | |
| ESCALA | TRIÁNGULO DE SUJECCIÓN A 30° | | N° PLANO |
| 1/26 | | | 1 |

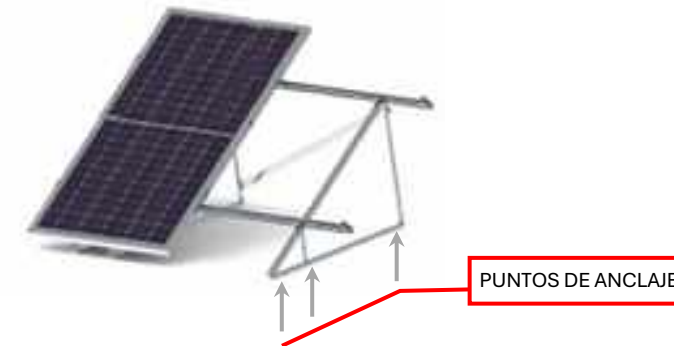
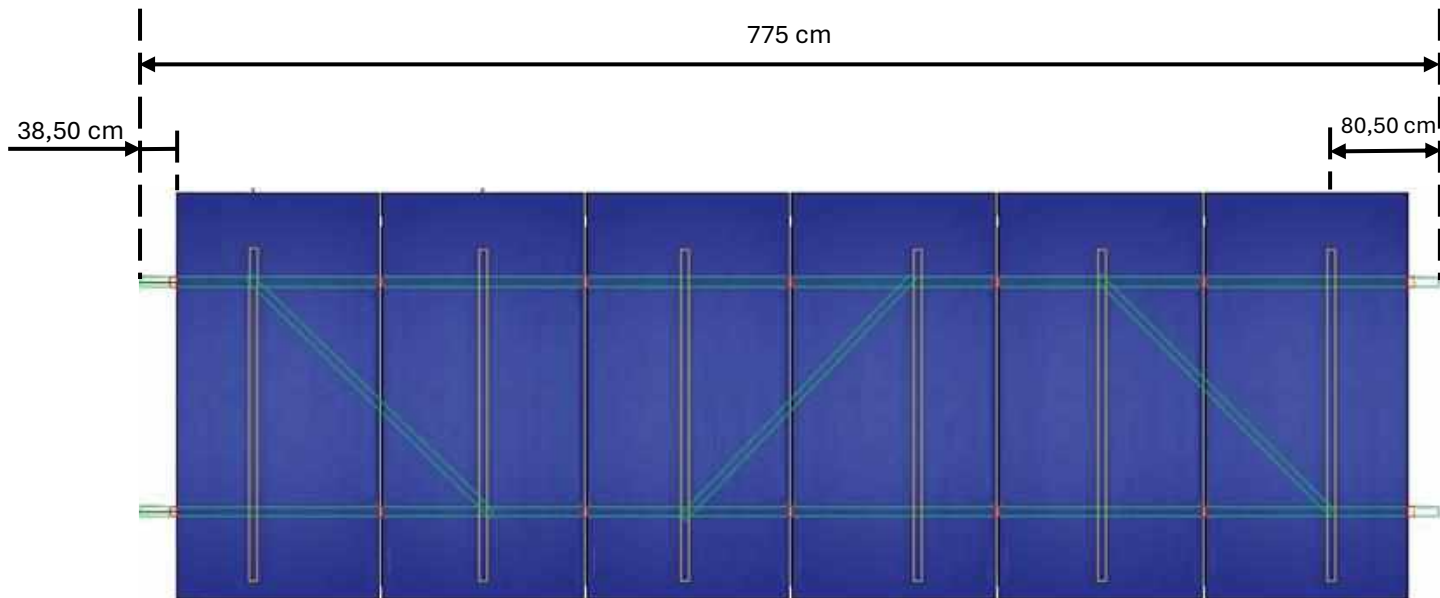

COMPONENTES

| | | |
|------------------------|---|-------|
| TRIÁNGULO L1700 |  | 6 UD |
| GUÍA PRO 165 |  | 8 UD |
| GUÍA PRO 115 |  | 2 UD |
| GRAPA GUÍA PRO STANDAR | | 12 UD |
| TUBO 45*20 L1445 | | 3 UD |
| KIT TORNILLERIA | | 6 UD |
| END CLAMP |  | 4 UD |
| INTER CLAMP |  | 10 UD |
| EMPALME GUÍA PRO | | 8 UD |

SEPARACIÓN DE TRIÁNGULOS **120 cm**

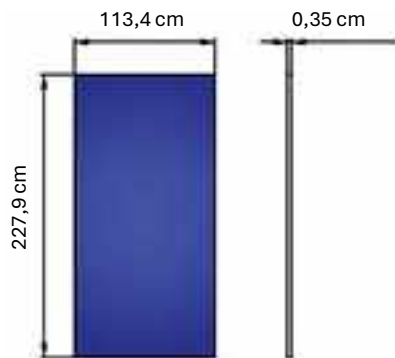

| | | | |
|---|-------------------------|---------|------------------------|
| PLANO | DISTRIBUCIÓN 1X6 | COUNTRY | ESPAÑA |
|  Renovables del Sur Estamos cambiando el mundo | | ESCALE | PAGE SIZE A4 |

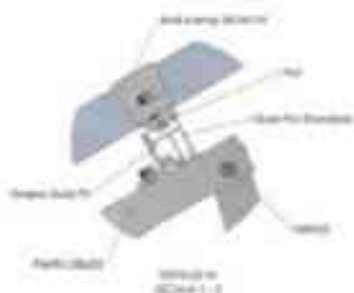
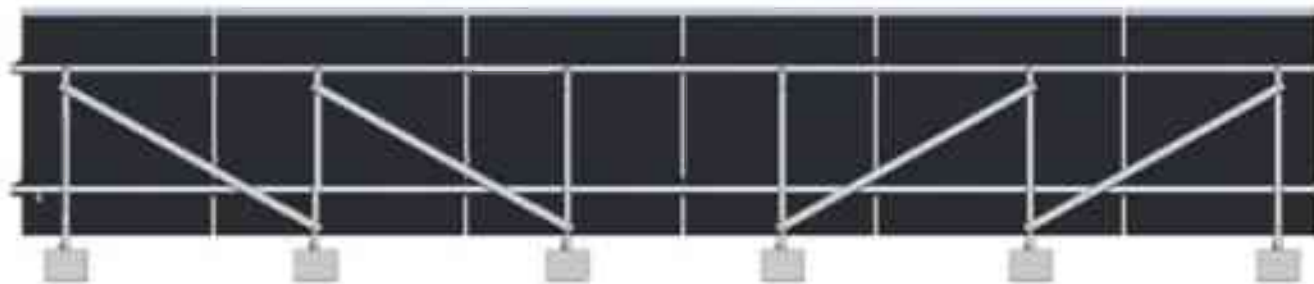
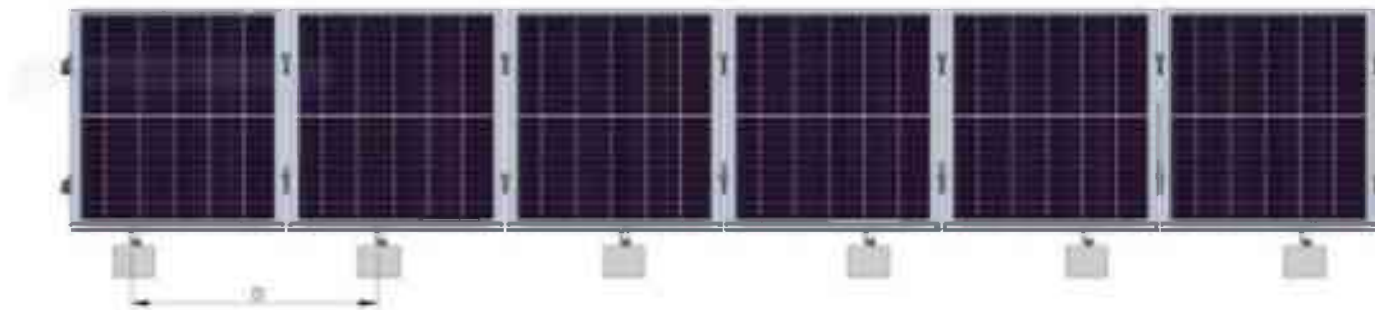

ESTRUCTURA TRIANGULAR TI-V

| REV | FECHA | DESCRIPCIÓN | DISEÑADO |
|-----|------------|-------------|----------|
| 1 | 19/01/2022 | Vertical | DC |
| 2 | | | |

| | | | |
|-------------|--|---|--|
| CLIENTE | |  | |
| UBICACIÓN | | | |
| COORDENADAS | | | |

| | | |
|----------------|------------------------------|---------------|
| ESCALA 1:25 | TRIÁNGULO DE SUJECCIÓN A 30° | N° PLANO 1 |
|----------------|------------------------------|---------------|